

रोल नं.

--	--	--	--	--	--	--

Roll No.

परीक्षार्थी कोड को उत्तर-पुस्तिका के मुख-पृष्ठ पर अवश्य लिखें।

Candidates must write the Code on the title page of the answer-book.

- कृपया जाँच कर लें कि इस प्रश्न-पत्र में मुद्रित पृष्ठ 16 हैं।
- प्रश्न-पत्र में दाहिने हाथ की ओर दिए गए कोड नम्बर को छात्र उत्तर-पुस्तिका के मुख-पृष्ठ पर लिखें।
- कृपया जाँच कर लें कि इस प्रश्न-पत्र में 26 प्रश्न हैं।
- कृपया प्रश्न का उत्तर लिखना शुरू करने से पहले, प्रश्न का क्रमांक अवश्य लिखें।
- इस प्रश्न-पत्र को पढ़ने के लिए 15 मिनट का समय दिया गया है। प्रश्न-पत्र का वितरण पूर्वाह्न में 10.15 बजे किया जाएगा। 10.15 बजे से 10.30 बजे तक छात्र केवल प्रश्न-पत्र को पढ़ेंगे और इस अवधि के दौरान वे उत्तर-पुस्तिका पर कोई उत्तर नहीं लिखेंगे।
- Please check that this question paper contains 16 printed pages.
- Code number given on the right hand side of the question paper should be written on the title page of the answer-book by the candidate.
- Please check that this question paper contains 26 questions.
- **Please write down the Serial Number of the question before attempting it.**
- 15 minute time has been allotted to read this question paper. The question paper will be distributed at 10.15 a.m. From 10.15 a.m. to 10.30 a.m., the students will read the question paper only and will not write any answer on the answer-book during this period.

भौतिक विज्ञान (सैद्धान्तिक)

PHYSICS (Theory)

निर्धारित समय : 3 घण्टे

अधिकतम अंक : 70

Time allowed : 3 hours

Maximum Marks : 70

55/3/RU

1

P.T.O.



सामान्य निर्देश :

- (i) सभी प्रश्न अनिवार्य हैं। इस प्रश्न-पत्र में कुल 26 प्रश्न हैं।
- (ii) इस प्रश्न-पत्र के 5 भाग हैं : खण्ड अ, खण्ड ब, खण्ड स, खण्ड द और खण्ड य।
- (iii) खण्ड अ में 5 प्रश्न हैं, प्रत्येक का 1 अंक है। खण्ड ब में 5 प्रश्न हैं, प्रत्येक के 2 अंक हैं। खण्ड स में 12 प्रश्न हैं, प्रत्येक के 3 अंक हैं। खण्ड द में 4 अंक का एक मूल्याधारित प्रश्न है और खण्ड य में 3 प्रश्न हैं, प्रत्येक के 5 अंक हैं।
- (iv) प्रश्न-पत्र में समग्र पर कोई विकल्प नहीं है। तथापि, दो अंकों वाले एक प्रश्न में, तीन अंकों वाले एक प्रश्न में और पाँच अंकों वाले तीनों प्रश्नों में आन्तरिक चयन प्रदान किया गया है। ऐसे प्रश्नों में आपको दिए गए चयन में से केवल एक प्रश्न ही करना है।
- (v) जहाँ आवश्यक हो आप निम्नलिखित भौतिक नियतांकों के मानों का उपयोग कर सकते हैं :

$$c = 3 \times 10^8 \text{ m/s}$$

$$h = 6.63 \times 10^{-34} \text{ Js}$$

$$e = 1.6 \times 10^{-19} \text{ C}$$

$$\mu_0 = 4\pi \times 10^{-7} \text{ T m A}^{-1}$$

$$\epsilon_0 = 8.854 \times 10^{-12} \text{ C}^2 \text{ N}^{-1} \text{ m}^{-2}$$

$$\frac{1}{4\pi\epsilon_0} = 9 \times 10^9 \text{ N m}^2 \text{ C}^{-2}$$

$$m_e = 9.1 \times 10^{-31} \text{ kg}$$

$$\text{न्यूट्रॉन का द्रव्यमान} = 1.675 \times 10^{-27} \text{ kg}$$

$$\text{प्रोटॉन का द्रव्यमान} = 1.673 \times 10^{-27} \text{ kg}$$

$$\text{आवोगाद्रो संख्या} = 6.023 \times 10^{23} \text{ प्रति ग्राम मोल}$$

$$\text{बोल्ट्ज़मान नियतांक} = 1.38 \times 10^{-23} \text{ JK}^{-1}$$



General Instructions :

- (i) *All questions are compulsory. There are 26 questions in all.*
- (ii) *This question paper has five sections : Section A, Section B, Section C, Section D and Section E.*
- (iii) *Section A contains five questions of one mark each, Section B contains five questions of two marks each, Section C contains twelve questions of three marks each, Section D contains one value based question of four marks and Section E contains three questions of five marks each.*
- (iv) *There is no overall choice. However, an internal choice has been provided in one question of two marks, one question of three marks and all the three questions of five marks weightage. You have to attempt only one of the choices in such questions.*
- (v) *You may use the following values of physical constants wherever necessary :*

$$c = 3 \times 10^8 \text{ m/s}$$

$$h = 6.63 \times 10^{-34} \text{ Js}$$

$$e = 1.6 \times 10^{-19} \text{ C}$$

$$\mu_0 = 4\pi \times 10^{-7} \text{ T m A}^{-1}$$

$$\epsilon_0 = 8.854 \times 10^{-12} \text{ C}^2 \text{ N}^{-1} \text{ m}^{-2}$$

$$\frac{1}{4\pi\epsilon_0} = 9 \times 10^9 \text{ N m}^2 \text{ C}^{-2}$$

$$m_e = 9.1 \times 10^{-31} \text{ kg}$$

$$\text{Mass of neutron} = 1.675 \times 10^{-27} \text{ kg}$$

$$\text{Mass of proton} = 1.673 \times 10^{-27} \text{ kg}$$

$$\text{Avogadro's number} = 6.023 \times 10^{23} \text{ per gram mole}$$

$$\text{Boltzmann constant} = 1.38 \times 10^{-23} \text{ JK}^{-1}$$



खण्ड अ

SECTION A

1. स्वच्छ आकाश में नीले रंग की प्रधानता क्यों होती है ? 1
Why does bluish colour predominate in a clear sky ?
2. स्थिर-वैद्युत क्षेत्र रेखाएँ संवृत (बंद) पाश क्यों नहीं बनाती हैं ? 1
Why do the electrostatic field lines not form closed loops ?
3. टेलीफ़ोन संचार में किस मूल संचार विधि का उपयोग होता है ? 1
Which basic mode of communication is used for telephonic communication ?
4. किसी कुंडली के 'स्वप्रेरकत्व' पद की परिभाषा दीजिए । इसका एस.आई. (S.I.) मात्रक लिखिए । 1
Define the term 'self-inductance' of a coil. Write its S.I. unit.
5. धातु के किसी तार के लिए दो विभिन्न तापों T_1 तथा T_2 पर $I - V$ आलेख (ग्राफ़) चित्र में दर्शाए गए हैं । इन दोनों तापों में से कौन-सा ताप दूसरे से कम है और क्यों ? 1

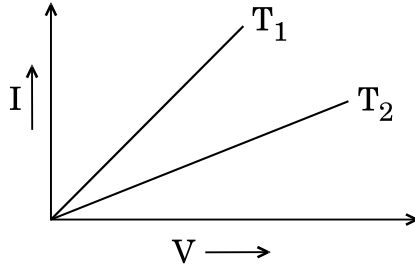

$I - V$ graph for a metallic wire at two different temperatures, T_1 and T_2 is as shown in the figure. Which of the two temperatures is lower and why ?

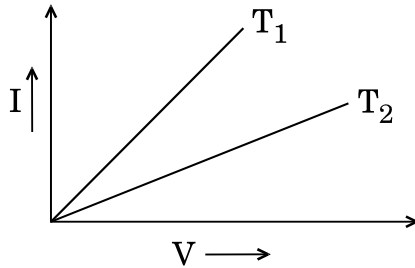

खण्ड ब

SECTION B

6. हाइड्रोजन परमाणु के स्पेक्ट्रम में बामर श्रेणी की सबसे कम (न्यूनतम) तरंगदैर्घ्य का मान परिकलित कीजिए । यह तरंगदैर्घ्य हाइड्रोजन परमाणु के स्पेक्ट्रम के किस भाग (अवरक्त, दृश्य, पराबैंगनी) में होगी ?

2

Calculate the shortest wavelength in the Balmer series of hydrogen atom. In which region (infra-red, visible, ultraviolet) of hydrogen spectrum does this wavelength lie ?

7. आरेख में दर्शाए गए विद्युत् परिपथ जाल में, भुजा BE से विद्युत् प्रवाह न होने की स्थिति में, बिन्दुओं A तथा D के बीच विभवान्तर का मान, किरखोफ के नियमों के उपयोग से ज्ञात कीजिए ।

2

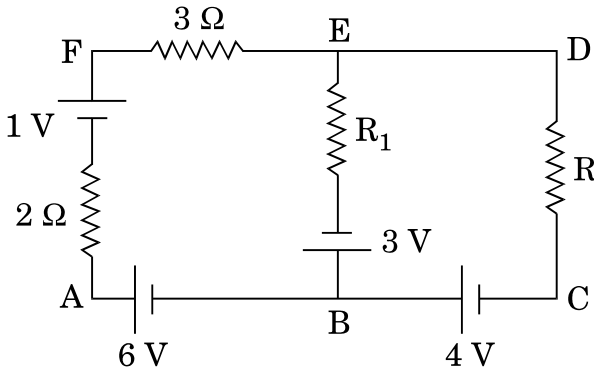

Use Kirchoff's rules to determine the potential difference between the points A and D when no current flows in the arm BE of the electric network shown in the figure.

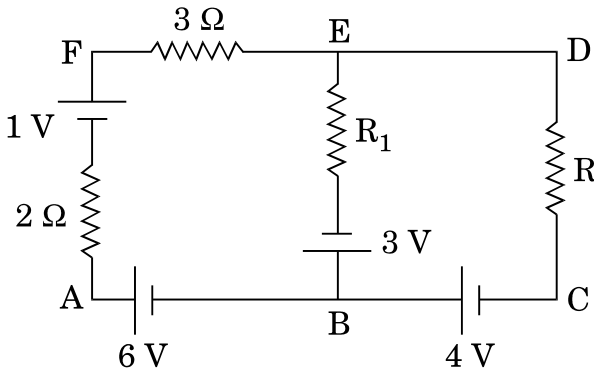

8. एक संयुक्त सूक्ष्मदर्शी बनाने के लिए आपको 1.25 cm तथा 5 cm फोकस दूरियों के दो अभिसारी लेंस दिए गए हैं। यदि इस सूक्ष्मदर्शी से 30 आवर्धन क्षमता प्राप्त करनी हो, तो अभिदृश्यक तथा नेत्रिका के बीच की दूरी ज्ञात कीजिए।

2

अथवा

किसी छोटे दूरदर्शी के अभिदृश्यक लेंस तथा नेत्रिका की फोकस दूरियाँ क्रमशः 150 cm तथा 5 cm हैं। सामान्य संयोजन में दूर स्थित वस्तुओं को देखने के लिए दूरदर्शी की आवर्धन क्षमता कितनी होगी ?

यदि इस दूरदर्शी से 3 किलोमीटर दूर स्थित 100 m ऊँचे टावर (मीनार) को देखा जाए, तो अभिदृश्यक लेंस द्वारा बनाए गए टावर के प्रतिबिम्ब की ऊँचाई कितनी होगी ?

2

You are given two converging lenses of focal lengths 1.25 cm and 5 cm to design a compound microscope. If it is desired to have a magnification of 30, find out the separation between the objective and the eyepiece.

OR

A small telescope has an objective lens of focal length 150 cm and eyepiece of focal length 5 cm. What is the magnifying power of the telescope for viewing distant objects in normal adjustment ?

If this telescope is used to view a 100 m tall tower 3 km away, what is the height of the image of the tower formed by the objective lens ?

9. प्रसारण से पहले निम्न आवृत्ति संकेतों को उच्च आवृत्ति संकेतों में माडुलन की आवश्यकता के औचित्य के लिए, दो कारकों का उल्लेख कीजिए।

2

Write two factors which justify the need of modulating a low frequency signal into high frequencies before transmission.

10. हाइड्रोजन परमाणु में जब कोई इलेक्ट्रॉन तृतीय उत्तेजित अवस्था से न्यूनतम ऊर्जा अवस्था में संक्रमण करता है, तो उस इलेक्ट्रॉन से सम्बद्ध दे ब्रॉग्ली तरंगदैर्घ्य में क्या परिवर्तन होगा ? अपने उत्तर की पुष्टि के लिए कारण लिखिए।

2

When an electron in hydrogen atom jumps from the third excited state to the ground state, how would the de Broglie wavelength associated with the electron change ? Justify your answer.



खण्ड स

SECTION C

11. x-अक्ष के अनुदिश, धनात्मक दिशा में एक एकसमान चुम्बकीय क्षेत्र \vec{B} स्थापित किया जाता है। 'q' आवेश तथा 'm' द्रव्यमान का एक कण, \vec{v} वेग से इस क्षेत्र में मूल-बिन्दु पर X-Y तल में इस प्रकार प्रवेश करता है कि इसके वेग-अवयव, चुम्बकीय क्षेत्र \vec{B} के अनुदिश तथा उसके लम्बवत्, दोनों ही दिशाओं में हैं। कारण देते हुए इस कण के प्रक्षेप-पथ का अनुरेखण कीजिए। इस कण द्वारा चुम्बकीय क्षेत्र के अनुदिश, एक चक्कर में तय की गई दूरी के लिए व्यंजक ज्ञात कीजिए।

3

A uniform magnetic field \vec{B} is set up along the positive x-axis. A particle of charge 'q' and mass 'm' moving with a velocity \vec{v} enters the field at the origin in X-Y plane such that it has velocity components both along and perpendicular to the magnetic field \vec{B} . Trace, giving reason, the trajectory followed by the particle. Find out the expression for the distance moved by the particle along the magnetic field in one rotation.

12. (a) दिए गए श्रेणी एल.सी.आर. (LCR) परिपथ में विद्युत् धारा तथा वोल्टता में कलान्तर का मान निर्धारित कीजिए।

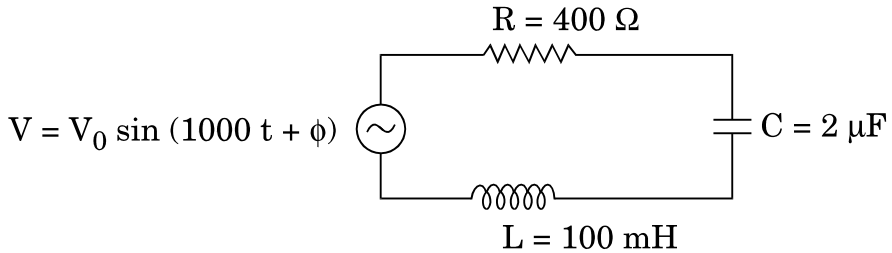

- (b) परिकल्पित कीजिए कि इस परिपथ में संधारित्र C के साथ कितनी धारिता का एक अतिरिक्त संधारित्र जोड़ा जाए कि परिपथ का शक्ति गुणांक एक (1) हो जाए।

3

- (a) Determine the value of phase difference between the current and the voltage in the given series LCR circuit.

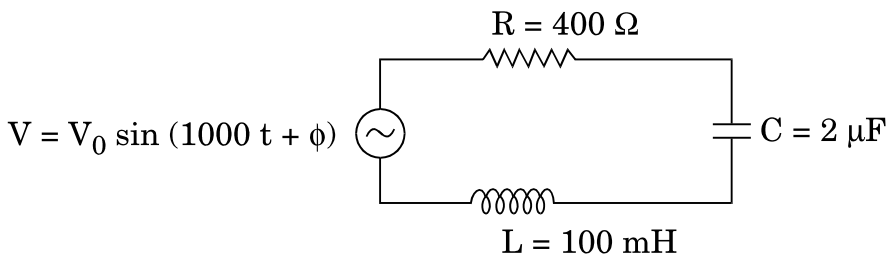

(b) Calculate the value of the additional capacitor which may be joined suitably to the capacitor C that would make the power factor of the circuit unity.

13. ऐम्पियर के परिपथीय नियम के व्यापकीकृत रूप के लिए व्यंजक लिखिए। इसके महत्त्व पर चर्चा कीजिए और संक्षेप में वर्णन कीजिए कि विस्थापन धारा की अभिधारणा को, किसी विद्युत् परिपथ में किसी संधारित्र के आवेशित व अनावेशित होने की घटना द्वारा कैसे समझाया जा सकता है।

3

Write the expression for the generalized form of Ampere's circuital law. Discuss its significance and describe briefly how the concept of displacement current is explained through charging/discharging of a capacitor in an electric circuit.

14. हाइगेन्स के सिद्धान्त के उपयोग से यह दर्शाइए कि कोई समतल तरंगाग्र सघन माध्यम से विरल माध्यम में कैसे संचरित होता है। इससे स्नैल के अपवर्तन नियम का सत्यापन कीजिए।

3

Use Huygens' principle to show how a plane wavefront propagates from a denser to rarer medium. Hence verify Snell's law of refraction.

15. आरेख में दर्शाए गए परिपथ में, संधारित्र C_2 का विभवान्तर तथा इसमें संचित ऊर्जा का मान परिकलित कीजिए। दिया गया है, A पर विभव 90 V, $C_1 = 20 \mu\text{F}$, $C_2 = 30 \mu\text{F}$ तथा $C_3 = 15 \mu\text{F}$ ।

3

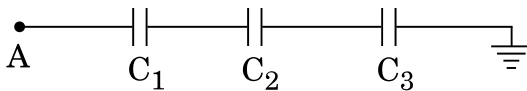

Calculate the potential difference and the energy stored in the capacitor C_2 in the circuit shown in the figure. Given potential at A is 90 V, $C_1 = 20 \mu\text{F}$, $C_2 = 30 \mu\text{F}$ and $C_3 = 15 \mu\text{F}$.

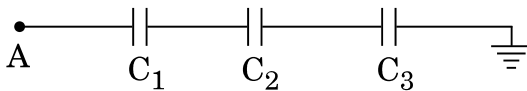

16. किसी चालक में आवेश वाहकों के अपवाह वेग तथा विश्रांति काल के बीच सम्बन्ध ज्ञात कीजिए।

L लम्बाई का एक चालक, 'E' विद्युत्-वाहक बल (इ.एम.एफ.) के एक डी.सी. (d.c.) स्रोत से जुड़ा है। यदि 'E' को स्थिर रखते हुए, चालक (तार) को खींचकर उसकी लम्बाई तीन गुना कर दी जाए, तो स्पष्ट कीजिए कि अपवाह वेग पर क्या प्रभाव होगा।

3



Find the relation between drift velocity and relaxation time of charge carriers in a conductor.

A conductor of length L is connected to a d.c. source of emf 'E'. If the length of the conductor is tripled by stretching it, keeping 'E' constant, explain how its drift velocity would be affected.

17. स्पष्ट कीजिए कि अध्रुवित प्रकाश किसी पोलैरोइड से होकर गुजरने के पश्चात् रैखिकतः ध्रुवित कैसे हो जाता है ।

(i) I_0 तीव्रता का अध्रुवित प्रकाश किसी पोलैरोइड P_1 पर आपतित होता है जिसको एक अन्य पोलैरोइड P_2 के पास रखा जाता है जिसका पारित-अक्ष P_1 के पारित-अक्ष के समान्तर है । P_2 को इसी अवस्था में स्थिर रखते हुए, यदि P_1 को घुमाया जाए, तो पोलैरोइडों P_1 तथा P_2 से पारगमित प्रकाश की तीव्रताओं, क्रमशः I_1 तथा I_2 में क्या परिवर्तन होगा ?

(ii) I_1 तथा I_2 तीव्रताओं के बीच सम्बन्ध लिखिए ।

3

State clearly how an unpolarised light gets linearly polarised when passed through a polaroid.

(i) Unpolarised light of intensity I_0 is incident on a polaroid P_1 which is kept near another polaroid P_2 whose pass axis is parallel to that of P_1 . How will the intensities of light, I_1 and I_2 , transmitted by the polaroids P_1 and P_2 respectively, change on rotating P_1 without disturbing P_2 ?

(ii) Write the relation between the intensities I_1 and I_2 .

18. माडुलन सूचकांक को परिभाषित कीजिए । व्यवहार में इसका मान एक (1) से कम क्यों रखा जाता है ?

1.5 MHz आवृत्ति तथा 50 V आयाम की एक वाहक तरंग को 10 kHz आवृत्ति की किसी ज्यावक्रीय तरंग द्वारा माडुलित किया जाता है जिससे 50% आयाम माडुलन उत्पन्न होता है । आयाम माडुलित (A.M.) तरंग के आयाम तथा उत्पन्न पार्श्व बैंडों की आवृत्तियों का परिकलन कीजिए ।

3

Define modulation index. Why is its value kept, in practice, less than one ?

A carrier wave of frequency 1.5 MHz and amplitude 50 V is modulated by a sinusoidal wave of frequency 10 kHz producing 50% amplitude modulation. Calculate the amplitude of the AM wave and frequencies of the side bands produced.

19. (a) नाभिकीय बल के तीन अभिलक्षणिक गुण लिखिए ।
 (b) एक न्यूक्लियॉन युग्म के पृथक्करण के फलन के रूप में स्थितिज ऊर्जा का एक आलेख बनाइए । उन दो महत्वपूर्ण निष्कर्षों को लिखिए जो इस आलेख (ग्राफ़) से निकाले जा सकते हैं ।

3

- (a) Write three characteristic properties of nuclear force.
 (b) Draw a plot of potential energy of a pair of nucleons as a function of their separation. Write two important conclusions that can be drawn from the graph.

20. (a) प्रकाश-विद्युत् प्रभाव की परिघटना में तीन प्रायोगिक अध्ययन से प्रेक्षित लक्षणों का संक्षेप में वर्णन कीजिए ।
 (b) संक्षेप में चर्चा कीजिए कि इन लक्षणों की व्याख्या, प्रकाश के तरंग सिद्धान्त द्वारा क्यों नहीं हो सकती ।

3

अथवा

- (a) फ़ोटॉनों के उन मुख्य गुणधर्मों का उल्लेख कीजिए जिनका उपयोग आइन्स्टाइन के प्रकाश-विद्युत् समीकरण को स्थापित करने में किया जाता है ।
 (b) इस समीकरण से (i) देहली आवृत्ति तथा (ii) निरोधी विभव की धारणाओं की व्याख्या कीजिए ।

3

- (a) Describe briefly three experimentally observed features in the phenomenon of photoelectric effect.
 (b) Discuss briefly how wave theory of light cannot explain these features.

OR

- (a) Write the important properties of photons which are used to establish Einstein's photoelectric equation.
 (b) Use this equation to explain the concept of (i) threshold frequency and (ii) stopping potential.
21. यहाँ दर्शाए गए आरेख में P तथा Q गेटों (द्वारों) को पहचानिए । इनके दर्शाए गए गेटों (द्वारों) के संयोजन के लिए सत्यमान सारणी बनाइए ।

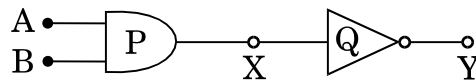

इस परिपथ को निरूपित करने के लिए तुल्य गेट (द्वार) का नाम लिखिए तथा उसका तर्क प्रतीक लिखिए ।

3



Identify the gates P and Q shown in the figure. Write the truth table for the combination of the gates shown.

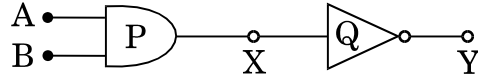

Name the equivalent gate representing this circuit and write its logic symbol.

22. किसी सी.ई. (C.E.) ट्रांजिस्टर प्रवर्धक का परिपथ आरेख बनाइए । इसकी कार्यविधि को संक्षेप में स्पष्ट कीजिए तथा इस प्रवर्धक की (i) धारा लब्धि, (ii) वोल्टता लब्धि के लिए व्यंजक लिखिए ।

3

Draw a circuit diagram of a C.E. transistor amplifier. Briefly explain its working and write the expression for (i) current gain, (ii) voltage gain of the amplifier.

खण्ड द

SECTION D

23. एक दिन प्रातःकाल में एक वृद्ध व्यक्ति नंगे पाँव अपने घर में पावर सप्लाइ के मेन-स्विच के विद्युत्-फ्यूज को बदलने का प्रयत्न कर रहा था । एकाएक वह चीखकर फ़र्श पर गिर पड़ा । चीख सुनकर उसकी पत्नी सहायता के लिए चिल्लाई । उसे सुनकर उनके पड़ोसी का बेटा अनिल जूते पहनकर वहाँ पहुँचा और लकड़ी की छड़ी से उसने मेन सप्लाइ के स्विच को बन्द कर दिया ।

निम्नलिखित प्रश्नों के उत्तर दीजिए :

4

- भारत में घरों में विद्युत् मेन सप्लाइ की वोल्टता तथा आवृत्ति कितनी है ?
- आजकल जिन विद्युत् युक्तियों का हम उपयोग करते हैं, उनमें से अधिकांश को ए.सी. (प्रत्यावर्ती धारा) वोल्टता की आवश्यकता होती है । क्यों ?
- क्या डी.सी. (d.c.) वोल्टता के मान के उच्चयन (बढ़ाने) के लिए ट्रांसफॉर्मर का उपयोग हो सकता है ?
- अपने कार्य से अनिल द्वारा प्रदर्शित दो गुणों का उल्लेख कीजिए ।

One morning an old man walked bare-foot to replace the fuse wire in kit kat fitted with the power supply mains for his house. Suddenly he screamed and collapsed on the floor. His wife cried loudly for help. His neighbour's son Anil heard the cries and rushed to the place with shoes on. He took a wooden baton and used it to switch off the main supply.

Answer the following questions :

- (i) What is the voltage and frequency of mains supply in India ?
- (ii) These days most of the electrical devices we use require a.c. voltage. Why ?
- (iii) Can a transformer be used to step up d.c. voltage ?
- (iv) Write two qualities displayed by Anil by his action.

खण्ड य

SECTION E

24. नामांकित आरेख की सहायता से किसी चल कुंडली धारामापी (गैल्वेनोमीटर) के कार्यकारी सिद्धान्त तथा कार्यविधि को स्पष्ट कीजिए । इसमें (i) एकसमान अरीय (त्रिज्य) चुम्बकीय क्षेत्र, (ii) नर्म लौह क्रोड का क्या प्रकार्य है ?
- किसी धारामापी (गैल्वेनोमीटर) के लिए उसकी (i) धारा सुग्राहिता तथा (ii) वोल्टता सुग्राहिता पदों की परिभाषा दीजिए । धारा सुग्राहिता में वृद्धि से वोल्टता सुग्राहिता का बढ़ना आवश्यक क्यों नहीं है ?

5

अथवा

- (a) किसी $d\vec{l}$ लम्बाई के अवयव से I धारा प्रवाहित हो रही है । इससे \vec{r} दूरी पर चुम्बकीय क्षेत्र \vec{B} के लिए एक व्यंजक सदिश रूप में, बायो – सार्वट नियम के उपयोग से लिखिए ।

इससे R त्रिज्या के किसी पाश (लूप) के केन्द्र से उसकी अक्ष के अनुदिश, x दूरी पर स्थित, किसी बिन्दु P पर चुम्बकीय क्षेत्र के लिए व्यंजक व्युत्पन्न कीजिए, यदि इस पाश से विद्युत् धारा प्रवाहित हो रही है ।



- (b) स्पष्ट कीजिए कि बायो – सावर्ट नियम से, ऐम्पियर के परिपथीय नियम को समाकलन (इंटीग्रल) रूप में यथा,

$$\oint \vec{B} \cdot d\vec{l} = \mu_0 I$$

के रूप में कैसे व्यक्त किया जा सकता है, जहाँ I उस पृष्ठ से होकर गुज़रने वाली कुल धारा है ।

5

Explain, using a labelled diagram, the principle and working of a moving coil galvanometer. What is the function of (i) uniform radial magnetic field, (ii) soft iron core ?

Define the terms (i) current sensitivity and (ii) voltage sensitivity of a galvanometer. Why does increasing the current sensitivity not necessarily increase voltage sensitivity ?

OR

- (a) Write, using Biot – Savart law, the expression for the magnetic field \vec{B} due to an element $d\vec{l}$ carrying current I at a distance \vec{r} from it in a vector form.

Hence derive the expression for the magnetic field due to a current carrying loop of radius R at a point P distant x from its centre along the axis of the loop.

- (b) Explain how Biot – Savart law enables one to express the Ampere's circuital law in the integral form, viz.,

$$\oint \vec{B} \cdot d\vec{l} = \mu_0 I$$

where I is the total current passing through the surface.

25. (a) दो कलासम्बद्ध स्रोतों S_1 तथा S_2 की एकवर्णी तरंगें उत्पन्न करने से व्यतिकरण पैटर्न बनता है । मान लीजिए S_1 द्वारा उत्पन्न तरंग का विस्थापन,

$$Y_1 = a \cos \omega t \text{ तथा } S_2 \text{ द्वारा उत्पन्न विस्थापन,}$$

$$Y_2 = a \cos (\omega t + \phi) \text{ है ।}$$

किसी बिन्दु पर परिणामी विस्थापन के आयाम के लिए व्यंजक प्राप्त कीजिए और दर्शाइए कि उस बिन्दु पर तीव्रता,

$$I = 4a^2 \cos^2 \phi/2, \text{ होगी ।}$$

इससे संपोषी तथा विनाशी व्यतिकरण के लिए प्रतिबन्ध (शर्तें) स्थापित कीजिए ।



- (b) यंग के द्वि-झिरी प्रयोग में व्यतिकरण फ्रिंजों पर क्या प्रभाव होता है, जब (i) स्रोत झिरी की चौड़ाई बढ़ा दी जाए; (ii) एकवर्णी स्रोत के स्थान पर श्वेत प्रकाश का स्रोत लिया जाए ?

5

अथवा

- (a) यहाँ दर्शाए गए आरेख में, प्रकाश की एक किरण 'PQ', काँच के प्रिज़्म ABC के फलक AB पर आपतित होकर फलक AC से निर्गत होती है। इस किरण के मार्ग का अनुरेखण कीजिए। दर्शाइए कि

$$\angle i + \angle e = \angle A + \angle \delta$$

जहाँ δ तथा e क्रमशः विचलन कोण व निर्गत कोण को निरूपित करते हैं।

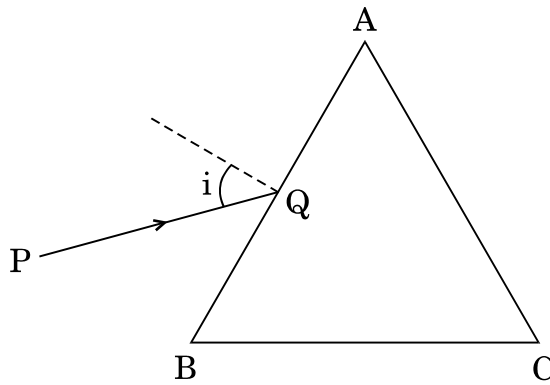

आपतन कोण के साथ विचलन कोण के परिवर्तन को दर्शाने के लिए एक ग्राफ़ (आलेख) बनाइए। $\angle \delta$ का मान न्यूनतम होने के लिए शर्त (प्रतिबन्ध) का उल्लेख कीजिए।

- (b) प्रिज़्म के कोण (A) का मान न्यूनतम विचलन कोण (δ_m) के बराबर होने की अवस्था में काँच के प्रिज़्म के अपवर्तनांक (μ) तथा $\angle A$ के बीच सम्बन्ध प्राप्त कीजिए। इससे प्रिज़्म कोण A का मान 60° होने के लिए अपवर्तनांक का मान प्राप्त कीजिए।

5

- (a) Consider two coherent sources S_1 and S_2 producing monochromatic waves to produce interference pattern. Let the displacement of the wave produced by S_1 be given by

$$Y_1 = a \cos \omega t$$

and the displacement by S_2 be

$$Y_2 = a \cos (\omega t + \phi).$$



Find out the expression for the amplitude of the resultant displacement at a point and show that the intensity at that point will be

$$I = 4a^2 \cos^2 \phi/2.$$

Hence establish the conditions for constructive and destructive interference.

- (b) What is the effect on the interference fringes in Young's double slit experiment when (i) the width of the source slit is increased; (ii) the monochromatic source is replaced by a source of white light ?

OR

- (a) A ray 'PQ' of light is incident on the face AB of a glass prism ABC (as shown in the figure) and emerges out of the face AC. Trace the path of the ray. Show that

$$\angle i + \angle e = \angle A + \angle \delta$$

where δ and e denote the angle of deviation and angle of emergence respectively.

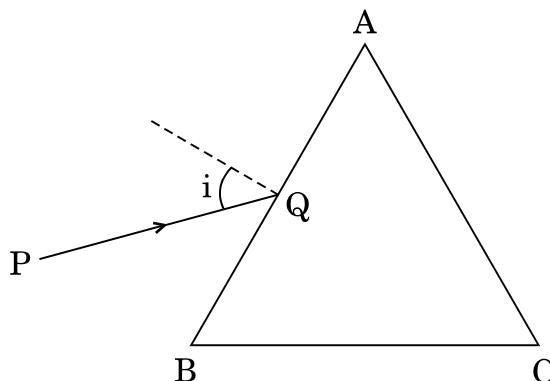

Plot a graph showing the variation of the angle of deviation as a function of angle of incidence. State the condition under which $\angle \delta$ is minimum.

- (b) Find out the relation between the refractive index (μ) of the glass prism and $\angle A$ for the case when the angle of prism (A) is equal to the angle of minimum deviation (δ_m). Hence obtain the value of the refractive index for angle of prism $A = 60^\circ$.

26. (a) विद्युत् फ्लक्स को परिभाषित कीजिए । इसका एस.आई. (S.I.) मात्रक लिखिए ।
 “स्थिर-वैद्युतिकी में गाउस का नियम किसी भी आकार या साइज़ (आमाप) के संवृत पृष्ठों के लिए सत्य है ।” एक उपयुक्त उदाहरण की सहायता से इस कथन की पुष्टि कीजिए ।
- (b) गाउस के नियम के उपयोग द्वारा सिद्ध कीजिए कि एकसमान आवेशित गोलीय कोश (खोल) के भीतर विद्युत्-क्षेत्र का मान शून्य होता है ।

5

अथवा

- (a) किसी समान्तर पट्टिका (प्लेट) संधारित्र में संचित ऊर्जा के लिए व्यंजक व्युत्पन्न कीजिए । इससे किसी विद्युत्-क्षेत्र के ऊर्जा घनत्व के लिए व्यंजक प्राप्त कीजिए ।
- (b) पूर्ण रूप से आवेशित एक समान्तर पट्टिका (प्लेट) संधारित्र को एक अन्य सर्वसम (ठीक इसी प्रकार के) अनावेशित संधारित्र के दो सिरों से जोड़ा गया है । यह दर्शाइए कि इस संयोजन में संचित ऊर्जा का मान प्रारम्भ में आवेशित (एकल) संधारित्र में संचित ऊर्जा के मान से कम होगा ।

5

- (a) Define electric flux. Write its S.I. unit.

“Gauss’s law in electrostatics is true for any closed surface, no matter what its shape or size is.” Justify this statement with the help of a suitable example.

- (b) Use Gauss’s law to prove that the electric field inside a uniformly charged spherical shell is zero.

OR

- (a) Derive the expression for the energy stored in a parallel plate capacitor. Hence obtain the expression for the energy density of the electric field.
- (b) A fully charged parallel plate capacitor is connected across an uncharged identical capacitor. Show that the energy stored in the combination is less than that stored initially in the single capacitor.



MARKING SCHEME
SET 55/1/RU

No.	Expected Answer / Value Points	Marks	Total Marks								
Section A											
t1, Q1 t2, Q5 t3, Q4	<p>Self inductance of the coil is numerically equal to magnetic flux linked with it when unit current flows through it. / Self inductance is numerically equal to induced emf in the coil when rate of change of current is unity.</p> <p>Unit- Henry or / volt-second/ ampere / weber ampere⁻¹</p>	<p>½</p> <p>½</p>	<p>1</p>								
t1, Q2 t2, Q3 t3, Q1	<p>Scattering of the blue colour is maximum due to its shorter wavelength / As per Rayleigh scattering law, the amount of scattering varies inversely with the fourth power of wavelength.</p>	<p>1</p>	<p>1</p>								
t1, Q3 t2, Q4 t3, Q5	<p>T₁</p> <p>Since slope(= $\frac{1}{Resistance}$) of T₁ is greater / Resistance of the wire at T₁ is lower.</p>	<p>½</p> <p>½</p>	<p>1</p>								
t1, Q4 t2, Q2 t3, Q3	<p>Point to Point communication mode</p>	<p>1</p>	<p>1</p>								
t1, Q5 t2, Q1 t3, Q2	<p>Due to conservative nature of electric field / These lines start from the positive charges and terminate at the negative charges.</p> <p><u>Alternatively.</u> There are two kinds of electric charges (positive and negative) (which acts as the 'source' and 'sink' for the electric field lines.)</p>	<p>1</p>	<p>1</p>								
Section B											
t1, Q6 t2, Q8 t3, Q10	<table border="1" style="width: 100%; border-collapse: collapse;"> <tr> <td style="padding: 5px;">Formula for Energy</td> <td style="text-align: right; padding: 5px;">½</td> </tr> <tr> <td style="padding: 5px;">Formula for de-Broglie wavelength</td> <td style="text-align: right; padding: 5px;">½</td> </tr> <tr> <td style="padding: 5px;">Calculation</td> <td style="text-align: right; padding: 5px;">½</td> </tr> <tr> <td style="padding: 5px;">Effect on wavelength</td> <td style="text-align: right; padding: 5px;">½</td> </tr> </table> <p>$\lambda = \frac{h}{p} = \frac{h}{\sqrt{2mK}}$</p> <p>$\frac{\lambda_1}{\lambda_4} = \sqrt{\frac{K_4}{K_1}}$</p> <p>But $K_n (= -E_n) \propto \frac{1}{n^2}$</p> <p>Hence, $\frac{\lambda_1}{\lambda_4} = \sqrt{\frac{1}{16}}$</p> <p>$\therefore \frac{\lambda_1}{\lambda_4} = \frac{1}{4}$</p>	Formula for Energy	½	Formula for de-Broglie wavelength	½	Calculation	½	Effect on wavelength	½	<p>½</p> <p>½</p> <p>½</p> <p>½</p>	<p>1</p>
Formula for Energy	½										
Formula for de-Broglie wavelength	½										
Calculation	½										
Effect on wavelength	½										



	<p>Alternatively</p> $\lambda_n = \frac{h}{p_n} = \frac{h}{mv_n}$ <p>Velocity of electron in n^{th} state $v_n \propto \frac{1}{n}$</p> $\lambda_n \propto \frac{1}{v_n} \therefore \lambda \propto n$ $\therefore \frac{\lambda_4}{\lambda_1} = \frac{n_4}{n_1} = \frac{4}{1}$	<p>$\frac{1}{2}$</p> <p>$\frac{1}{2}$</p> <p>$\frac{1}{2}$</p> <p>$\frac{1}{2}$</p>	<p>2</p> <p>2</p>
--	-----------------------------------------------------------------------------------------------------------------------------------------------------------------------------------------------------------------------------------------------------------------------------------------------------------------------	---------------------------------------------------------------------------------------------------------------------------------	-------------------

<p>t1, Q7 t 2, Q6 t 3, Q9</p>	<p>Any two Factors 1 + 1</p> <ol style="list-style-type: none"> 1. Size of the antenna or aerial or ($L \sim \frac{\lambda}{4}$) 2. Increase in effective power radiated by an Antenna (OR Power radiated $\propto \left(\frac{1}{\lambda}\right)^2$) 3. To minimize mixing of signals from different transmitters (Any two) 	<p>1 + 1</p>	<p>2</p>
---------------------------------------	------------------------------------------------------------------------------------------------------------------------------------------------------------------------------------------------------------------------------------------------------------------------------------------------------------------------------------------------------------------------------------------------------------------------	--------------	----------

<p>t1, Q8 t 2, Q9 t 3, Q7</p>	<p>Labeling of current in different branches of the circuit $\frac{1}{2}$</p> <p>Calculation 1</p> <p>Result $\frac{1}{2}$</p>		
		<p>$\frac{1}{2}$</p>	
	<p>According to Kirchoff's Junction law at B</p> $i_3 = i_1 + i_2 \quad \therefore i_3 = i_1$ <p>(As $i_2=0$ (given))</p> <p>Applying second law to loop AFEB</p> $i_3 \times 2 + i_3 \times 3 + i_2 R_1 = 1 + 3 + 6$ $\therefore i_3 = i_1 = 2 A$	<p>$\frac{1}{2}$</p>	
	<p>From A to D along AFD $\therefore V_{AD} = 2i_3 - 1 + 3 \times i_3$</p> $= (4 - 1 + 6)V$ $= 9 V$ <p>[Alternatively, if the student determine value of V_{AD} by finding the value of R, award full marks.]</p>	<p>$\frac{1}{2}$</p>	

t1, Q9
t 2, Q10
t 3, Q8

Formula for magnification	½
Substitution and Calculation	1
Result	½

$$M = m_o \times m_e$$

$$= \frac{L}{f_o} \left(1 + \frac{D}{f_e} \right)$$

$$\therefore 30 = \frac{L}{1.25} \left(1 + \frac{25}{5} \right)$$

$$30 \times 1.25 = L \times 6$$

$$L = 5 \times 1.25$$

$$= 6.25 \text{ cm}$$

½

½

½

½

2

OR

Formula for magnification	½
Calculation & Result	½
Angular magnification	½
Height of image	½

$$M = \frac{f_o}{f_e}$$

$$\therefore M = \frac{150}{5} = 30$$

For objective lens,

$$\frac{1}{v_o} - \frac{1}{u_o} = \frac{1}{f_o}$$

$$\frac{1}{v_o} = \frac{1}{1.5} - \frac{1}{3000}$$

$$\therefore v_o = \frac{3000}{1999} \approx 1.5$$

$$\frac{h_i}{h_o} = \frac{v_o}{u_o}$$

$$h_i = 100 \times \frac{1.5}{3 \times 10^3} = .05 \text{ m}$$

½

½

½

½

Alternatively,

$$\text{Angular size of the object} = \frac{100}{3 \times 1000} \text{ radian} = \frac{1}{30} \text{ radian}$$

$$\therefore \text{Angular size of image} = \left(\frac{1}{30} \times 30 \right) \text{ radian} = 1 \text{ radian}$$

$$\therefore \text{Height of image} = 1 \times \left(\frac{5}{100} \right) \text{ m} = 0.05 \text{ m}$$

½

½

1

2

t1, Q10
t 2, Q7
t 3, Q6

Formula	½
Substitution of correct value in formula	½
Value of λ	½
Region of wavelength	½

$$\frac{1}{\lambda} = R \left(\frac{1}{\lambda_1} - \frac{1}{\lambda_2} \right)$$

½

½

½

½

$\therefore \frac{1}{\lambda} = R \left(\frac{1}{4} - \frac{1}{\infty} \right)$ $= \frac{R}{4}$ $\lambda = 3640 \text{ \AA}$ $\therefore R = 1.09 \times 10^7 \text{ m}^{-1}$ <p>[Note: Since the value of R is not given, award full marks to the candidate if he writes $\lambda = \frac{4}{R}$]</p> <p>It will lie in Ultra Violet region (Give ½ mark if the student just writes, visible region)</p>	<p>½</p> <p>½</p> <p>½</p>	<p>2</p>
-----------------------------------------------------------------------------------------------------------------------------------------------------------------------------------------------------------------------------------------------------------------------------------------------------------------------------------------------------------------------------------------------------------------------------------	----------------------------	----------

Section C

<p>t1, Q11 t 2,Q18 t 3,Q15</p>	<table border="1" style="width: 100%;"> <tr> <td>Formula for net capacitance and its calculation</td> <td style="text-align: right;">½ + ½</td> </tr> <tr> <td>Calculation for net charge</td> <td style="text-align: right;">½</td> </tr> <tr> <td>Formula and calculation for P.d</td> <td style="text-align: right;">½</td> </tr> <tr> <td>Formula and calculation for energy stored</td> <td style="text-align: right;">½ + ½</td> </tr> </table> <p>Net Capacitance , $\frac{1}{C} = \frac{1}{C_1} + \frac{1}{C_2} + \frac{1}{C_3}$</p> $\frac{1}{C} = \frac{1}{20} + \frac{1}{30} + \frac{1}{15}$ $\therefore C = \frac{20}{3} \mu F$ <p>Net Charge on Capacitors</p> $q = CV$ $= \frac{20}{3} \times 10^{-6} \times 90 \text{ C}$ $= 600 \times 10^{-6} \text{ C}$ $= 600 \mu \text{ C (0.6 mC)}$ $\therefore P.d \text{ across } C_2 = \frac{q}{C_2}$ $= \frac{600 \times 10^{-6}}{30 \times 10^{-6}} \text{ V}$ $= 20 \text{ V}$ <p>Energy stored in capacitor across $C_2 = \frac{1}{2} C_2 V_2^2$</p> $= \frac{1}{2} \times 30 \times 10^{-6} \times 400$ $= 6 \times 10^{-3} \text{ J (= 6mJ)}$	Formula for net capacitance and its calculation	½ + ½	Calculation for net charge	½	Formula and calculation for P.d	½	Formula and calculation for energy stored	½ + ½	<p>½</p> <p>½</p> <p>½</p> <p>½</p> <p>½</p> <p>½</p> <p>½</p>	<p>3</p>
Formula for net capacitance and its calculation	½ + ½										
Calculation for net charge	½										
Formula and calculation for P.d	½										
Formula and calculation for energy stored	½ + ½										

<p>t1, Q12 t 2,Q19 t 3,Q16</p>	<table border="1" style="width: 100%;"> <tr> <td>Derivation of the Relation</td> <td style="text-align: right;">2</td> </tr> <tr> <td>Effect on drift velocity</td> <td style="text-align: right;">1</td> </tr> </table> <p>There being a random distribution, in the velocities of the charge carriers, their average velocity can be taken to be zero. We have, $F = ma = e F_E$ (F_E=electric field)</p>	Derivation of the Relation	2	Effect on drift velocity	1	<p>½</p> <p>½</p>	
Derivation of the Relation	2						
Effect on drift velocity	1						

	$v_d = \frac{eF_E\tau}{m}$ <p>Now, $F_E = \frac{P \cdot D}{\text{distance}}$ \therefore For given E, the field becomes $\frac{1}{3}rd$ when the length is made 3 times. Hence, $v'_d(\text{New}) = \frac{1}{3}v_d$</p> $\therefore v_{d'} = \frac{v_d}{3}$ <p>[Note: If explained by any other appropriate method award 1 mark for the explanation]</p>	<p>$\frac{1}{2}$</p> <p>$\frac{1}{2}$</p> <p>$\frac{1}{2}$</p>					3								
<p>t1, Q13 t 2, Q20 t 3, Q17</p>	<table border="1"> <tbody> <tr> <td>Explanation of Polarization through polarizer</td> <td>1</td> </tr> <tr> <td>Variation in I_1 and I_2</td> <td>1</td> </tr> <tr> <td>Relation between I_1 and I_2</td> <td>1</td> </tr> </tbody> </table> <p>Let unpolarized light be incident on a polaroid; its electric vectors, oscillating in a direction perpendicular to that of the alignment of the molecules in the polaroid, are able to pass through it while the component of light along the aligned molecules gets blocked. Hence the light gets linearly polarised.</p> <p>[Note : If student gives labelled diagram, award full marks.]</p> <p>I_1 will remain unaffected whereas I_2 will decrease from maximum ($=I_0/2$) to zero of the incident light. ($I_1 = \frac{I_0}{2}$)</p> $I_2 = I_1 \cos^2 \theta \quad / \quad I_2 = (I_0 / 2) \cos^2 \theta$	Explanation of Polarization through polarizer	1	Variation in I_1 and I_2	1	Relation between I_1 and I_2	1	<p>1</p> <p>1</p> <p>1</p>					3		
Explanation of Polarization through polarizer	1														
Variation in I_1 and I_2	1														
Relation between I_1 and I_2	1														
<p>t1, Q14 t 2, Q21 t 3, Q18</p>	<table border="1"> <tbody> <tr> <td>Definition of Modulation index</td> <td>1</td> </tr> <tr> <td>Reason</td> <td>$\frac{1}{2}$</td> </tr> <tr> <td>Calculation of USB and LSB</td> <td>$\frac{1}{2} + \frac{1}{2}$</td> </tr> <tr> <td>Amplitude of AM</td> <td>$\frac{1}{2}$</td> </tr> </tbody> </table> <p>The ratio of amplitude of modulating signal (E_m) and amplitude of carrier wave (E_c) is called modulating index.</p> <p>[Note: Also accept if only the formula ($\mu = \frac{E_m}{E_c}$) is given]</p> <p>To avoid /minimize distortion: Given: $f_c = 1.5 \text{ MHz}$ $f_m = 10 \text{ kHz} = 0.01 \text{ MHz}$</p> $\therefore \mu = \frac{E_m}{E_c}$ $\frac{50}{100} = \frac{E_m}{50}$ $E_m = 25 \text{ V}$ <p>USB frequency = $f_c + f_m$ $= (1.5 + 0.01) \text{ MHz}$ $= 1.51 \text{ MHz}$</p> <p>LSB frequency = $f_c - f_m$</p>	Definition of Modulation index	1	Reason	$\frac{1}{2}$	Calculation of USB and LSB	$\frac{1}{2} + \frac{1}{2}$	Amplitude of AM	$\frac{1}{2}$	<p>1</p> <p>$\frac{1}{2}$</p> <p>$\frac{1}{2}$</p>					
Definition of Modulation index	1														
Reason	$\frac{1}{2}$														
Calculation of USB and LSB	$\frac{1}{2} + \frac{1}{2}$														
Amplitude of AM	$\frac{1}{2}$														



t1, Q15
t 2, Q22
t 3, Q11

Trajectory of particle	1
Reason /explanation	1
Expression for distance travelled	1

Trajectory will be a helix

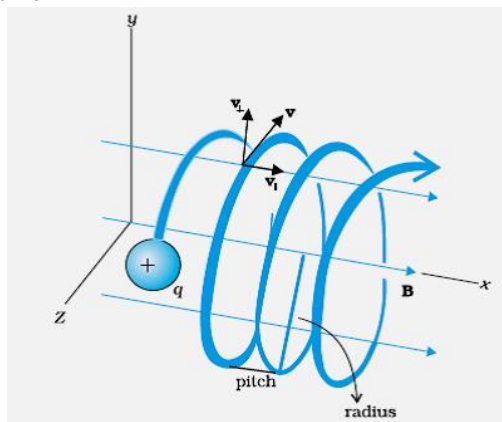

1

Explanation/Reason

The particle will describe a circle in the y-z plane, due to the component, v_y , of its velocity. It also moves along the x-axis (parallel to the field), due to the component v_x of its velocity. Hence its trajectory would be helical.

1

Distance moved along the magnetic field in one rotation

$$x = v_x \times T$$

$$\therefore T = \frac{2\pi m}{Bq}$$

$$\therefore x = \frac{2\pi m v_p}{Bq}$$

1/2

1/2

3

t1, Q16
t 2, Q14
t 3, Q12

(a) Value of phase difference	2
(b) Value of additional Capacitance	1

(a) In LCR circuit

$$\tan \varphi = \frac{X_L - X_C}{R} = \frac{\omega L - \frac{1}{\omega C}}{R}$$

1/2

$$\text{Now } X_L = \omega L = (1000 \times 100 \times 10^{-3}) \Omega$$

$$= 100 \Omega$$

1/2

$$\text{and } X_C = \frac{1}{\omega C} = \left(\frac{1}{1000 \times 2 \times 10^{-6}} \right) \Omega$$

$$\therefore X_C = 500 \Omega$$

1/2

$$\therefore \tan \varphi = \frac{500 - 100}{400} = 1$$

$$\tan \varphi = 1$$

(b) Power Factor

When power factor=1, we have $X_L=X_C$

$$\therefore X'_C = \frac{1}{\omega C'} = 100\Omega$$

This gives $C' = \frac{1}{100\omega} = 10\mu F$

We, therefore, need to add a capacitor of capacitance $(10-2)\mu F=8\mu F$ in parallel with the given capacitor.

Alternatively,

Let addition capacitance C_1 be connected

$$X'_C = \frac{1}{1000(2 + C_1) \times 10^{-6}}$$

$$\therefore 100 = \frac{1}{1000(2 + C_1) \times 10^{-6}}$$

$$\therefore 2 + C_1 = 10$$

$$C_1 = 8 \mu F$$

1/2

1/2

1/2

1/2

3

t1, Q17
t 2, Q15
t 3, Q13

Generalized form of Ampere's Circuital law	1
Significance	1
Explanation	1

Generalized form of Ampere Circuital law:

$$\oint \vec{B} \cdot d\vec{l} = \mu_0 \left(I_C + \epsilon_0 \frac{d\phi}{dt} \right)$$

1

It signifies that the source of magnetic field is not just due to the conduction electric current (I_C) due to flow of charge but also due to the time rate of change of electric field called displacement current.

1

During charging and discharging of a capacitor the electric field between the plates will change so there will be a change of electric flux (displacement current) between the plates.

1

3

t1, Q18
t 2, Q16
t 3, Q14

Labelled Diagram	1
Verification of Snell's law	2

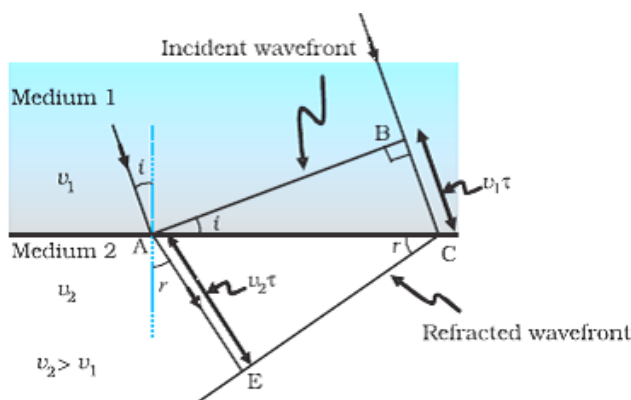

1

In ΔABC

In Δ CEA

$$\sin r = \frac{AE}{AC} = \frac{v_2 t}{AC}$$

$$\therefore \frac{\sin i}{\sin r} = \frac{BC}{AE} = \frac{v_1 t}{v_2 t} = \frac{v_1}{v_2}$$

$$\therefore \mu_1 = \frac{c}{v_1}$$

$$\mu_2 = \frac{c}{v_2}$$

$$\therefore \frac{\mu_2}{\mu_1} = \frac{v_1}{v_2}$$

$$\therefore \frac{\sin i}{\sin r} = \frac{\mu_2}{\mu_1}$$

or $\mu_2 \sin r = \mu_1 \sin i$ ----- It is Snell's law.

1/2

1/2

1/2

3

t1, Q19
t 2, Q17
t 3, Q21

Name of Gates P and Q

1/2 + 1/2

Truth Table

1

Equivalent Gate

1/2

Logic symbol of equivalent Gate

1/2

Gate P : **AND**

Gate Q : **NOT**

1/2

1/2

Truth table			
Input		X	Y
A	B		
0	0	0	1
0	1	0	1
1	0	0	1
1	1	1	0

1

Equivalent Gate: **NAND**

1/2

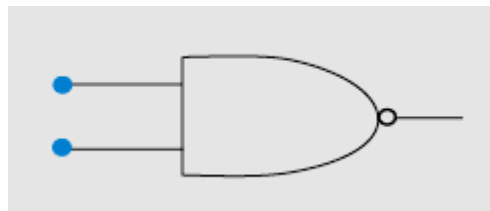

1/2

3

t1, Q20
t 2, Q11

Labeled Circuit diagram

1

Working of Amplifier

1

Expression for voltage gain

1/2

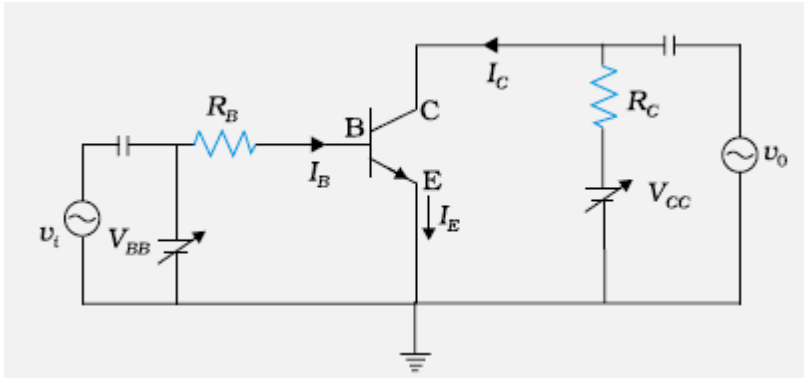

The input signal, connected between the emitter and base, along with the forward bias, causes corresponding large changes in output voltage across R.

Current gain

$$\beta_{ac} = \left| \frac{\Delta I_C}{\Delta I_B} \right|$$

Voltage gain

$$V_{Gain} = \frac{\Delta V_o}{\Delta V_i}$$

1

1

1/2

1/2

3

t1, Q21
t 2, Q12
t 3, Q19

Three characteristic properties

1/2 + 1/2 + 1/2

Graph for potential energy

1/2

Two conclusions

1/2 + 1/2

(a) Characteristic properties of Nuclear force

- i) Short range force
 - ii) Saturation forces
 - iii) Very Strong force
 - iv) Charge independent
- (Any Three)**

1/2

+1/2+1/2

(b)

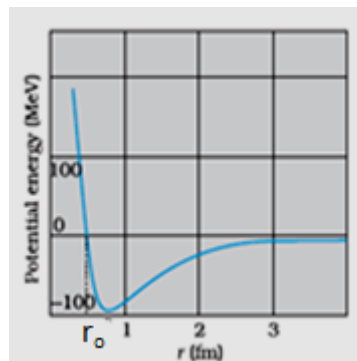

1/2

Conclusions

- i) Nuclear force is attractive for distance larger than r_0
- ii) Nuclear force is repulsive if two nucleons are separated by distance less than r_0
- iii) Nuclear force decreases very rapidly for $r > r_0$

1/2 + 1/2

t1, Q22
t 2, Q13
t 3, Q20

(a) Three experimental observations	$\frac{1}{2} + \frac{1}{2} + \frac{1}{2}$
(b) Failure of wave theory	1 $\frac{1}{2}$

- (a) 1. There is no emission of photoelectrons i.e. no current if the frequency of the incident radiation is below a certain minimum value however large may be the intensity of the light.
 2 The current varies directly with the intensity of the incident radiation.
 3. The current becomes zero at a certain value of negative potential, applied at the anode, this is known as stopping potential.
 4. The value of stopping potential increases with the increase in the frequency of the incident radiation.
 5. Maximum kinetic energy of the photo electrons does not depend upon intensity of light.
 6. Maximum kinetic energy of photoelectron increases with the frequency of the incident radiation.
 7. The process of photoelectric emission is instantaneous.

$\frac{1}{2} +$
 $\frac{1}{2} +$
 $\frac{1}{2}$

(Any three)

- (b) It fails to explain why
 1. The photo electric emission is instantaneous.
 2. There exists a threshold frequency for a given metal.
 3. The maximum KE of photoelectrons is independent of the intensity of incident radiation.

1 $\frac{1}{2}$

3

OR

(a) Two properties of photon	$\frac{1}{2} + \frac{1}{2}$
(b) Eienstein equation	1
Explanation of threshold frequency	$\frac{1}{2}$
Stopping potential	$\frac{1}{2}$

- (a)
 i) The energy of a photon is $h\nu$
 ii) Each photon is completely absorbed by a single electron.

$\frac{1}{2} + \frac{1}{2}$

- (b) $E_K = h\nu - W$
Alternatively, $h\nu = h\nu_0 + \frac{1}{2}mv_{max}^2$ or $h\nu = h\nu_0 + eV_0$
 or $E_k = h(\nu - \nu_0)$
(Any one)

1

- i. When Incident frequency < Threshold frequency, there will be no emission of electrons. Hence, frequency of incident radiation should be greater than threshold frequency. $(\nu_0 = \frac{W}{h})$

$\frac{1}{2}$

$$E_K = eV_0 = h\nu - W$$

$$\therefore V_0 = \frac{h}{e}\nu - \frac{W}{e}$$

Section D

t1, Q23 t 2,Q23 t 3,Q23	<table border="1" style="width: 100%; border-collapse: collapse;"> <tr> <td style="width: 60%;">Value of voltage and frequency in India</td> <td style="width: 40%; text-align: right;">1/2 + 1/2</td> </tr> <tr> <td>Reason of A.C being used more</td> <td style="text-align: right;">1/2</td> </tr> <tr> <td>Use of transformer with D.C</td> <td style="text-align: right;">1/2</td> </tr> <tr> <td>Two qualities of Anil</td> <td style="text-align: right;">1+ 1</td> </tr> </table>	Value of voltage and frequency in India	1/2 + 1/2	Reason of A.C being used more	1/2	Use of transformer with D.C	1/2	Two qualities of Anil	1+ 1		
Value of voltage and frequency in India	1/2 + 1/2										
Reason of A.C being used more	1/2										
Use of transformer with D.C	1/2										
Two qualities of Anil	1+ 1										
	<p>(i) voltage = 220 V frequency = 50 Hz</p>	1/2 1/2									
	<p>(ii) a) It can be stepped up / stepped down b)It can be converted into d.c c)Line losses can be minimised (any one)</p>	1/2									
	<p>(iii) No</p>	1/2									
	<p>(iv) Helping / Brave / Kind / Knowledge about AC or DC / Knowledge about insulator & conductors/ Awareness about safety precautions. (any two)</p>	1+1	3								

Section E

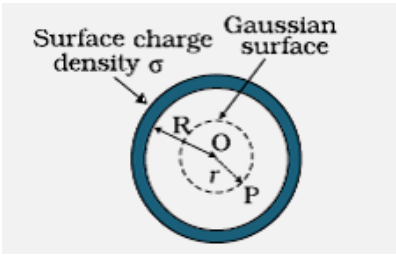
t1, Q24 t 2,Q25 t 3,Q26	<table border="1" style="width: 100%; border-collapse: collapse;"> <tr> <td style="width: 60%;">(a) Definition of electric flux and unit</td> <td style="width: 40%; text-align: right;">1 + 1/2</td> </tr> <tr> <td>Justification</td> <td style="text-align: right;">1/2</td> </tr> <tr> <td>(b) Proof</td> <td style="text-align: right;">1+1</td> </tr> </table>	(a) Definition of electric flux and unit	1 + 1/2	Justification	1/2	(b) Proof	1+1		
(a) Definition of electric flux and unit	1 + 1/2								
Justification	1/2								
(b) Proof	1+1								
	<p>a) Total number of electric lines of force passing perpendicular through a given surface. Unit – newton m² / coulomb (or V-m)</p> <p>According to Gauss theorem, the electric flux through a closed surface depends only on the net charge enclosed by the surface and not upon the shape or size of the surface.</p> <p>For any closed arbitrary slope of the surface enclosing a charge the outward flux is the same as that due to a spherical Gaussian surface enclosing the same charge.</p> <p>Justification: This is due to the fact</p> <p>(i) electric field is radial and</p> <p>(ii) the electric field $E \propto \frac{1}{R^2}$</p>	1 1/2 1/2 1							
									
	<p>∴ According to Gauss theorem , $\oint \vec{E} \cdot \vec{dS} = \frac{q}{\epsilon_0} = 0$</p>								



OR

(a) Derivation for energy stored	2
Derivation for energy density	1
(b) Required Proof	2

(a)

$$dU = dW = \int_0^q V dq$$

1/2

$$U = \int_0^q \frac{q}{C} dq$$

1/2

$$= \frac{1}{C} \left[\frac{q^2}{2} \right]_0^q$$

1/2

$$U = \frac{1}{C} \frac{q^2}{2} \text{ or } \frac{1}{2} CV^2$$

1/2

Energy Density $U = \frac{\text{Energy}}{\text{Volume}} = \frac{1}{2} \frac{CV^2}{A \cdot d}$

1/2

$$U = \frac{\frac{1}{2} CV^2}{A \cdot d}$$

But $C = \frac{\epsilon_0 A}{d}$ and $V = Ed$

$$\therefore U = \frac{1}{2} \epsilon_0 E^2$$

1/2

(b) Energy before connecting

$$U = \frac{1}{2} C_1 V_1^2$$

1/2

After connecting

$$\text{Common potential} = \frac{q_1 + q_2}{c_1 + c_2} = \frac{c_1 v_1}{c_1 + c_2}$$

1/2

$$\text{Energy Stored } U' = \frac{1}{2} (c_1 + c_2) \frac{c_1^2 v_1^2}{(c_1 + c_2)^2}$$

$$U' = \frac{1}{2} \frac{c_1^2 v_1^2}{(c_1 + c_2)}$$

1/2

$$= \frac{1}{2} \frac{c_1}{(c_1 + c_2)} U$$

$$\therefore U' < U$$

1/2

5

t1, Q25
t 2, Q26
t 3, Q24

Labelled diagram	1
Principle and working	1/2 + 1
Function of radial magnetic field and soft iron core	1/2 + 1/2
Current sensitivity	1/2



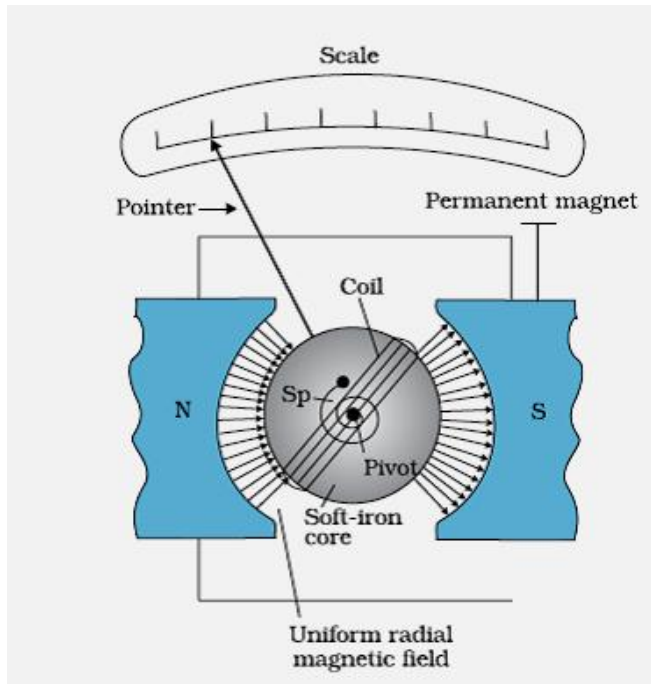

1

Principle : “Whenever a current carrying coil is placed in magnetic field, it experiences a deflecting torque.” 1/2

Working: When current is passed through a coil , free to rotate in a magnetic field , a deflecting torque ($=NiAB\sin\theta$) act on it. The coil starts to rotate . The rotation of coil is opposed, by spring S_p by providing a restoring torque ($=K\phi$). When the two torque becomes equal , coil comes to rest. 1/2

$$\therefore NiAB = K\phi$$

$$i = \frac{c\phi}{NAB} , \text{ Hence } i \propto \phi$$
1/2

Functions of (1) **Radial field** ; It keeps magnetic field lines normal to the area vector of the coil 1/2

(2) **Soft iron core**; It increases the strength of magnetic field. 1/2

Current sensitivity = deflection per unit current / $\left(\frac{\phi}{i} = \frac{NAB}{K}\right)$ 1/2

Voltage sensitivity : deflection per unit voltage / $\left(\frac{\phi}{V} = \frac{NAB}{KR}\right)$ 1/2

If $N \rightarrow 2N$, then by increasing number of turns, current sensitivity increases but voltage sensitivity remains same because resistance increases proportionally. 1/2

OR

(a) Expression for vector form of Biot-Savart law	1
Expression for magnetic field due to loop	3
(b) Biot-Savart law and Amperere’s Circuital law	1

5

(a) Biot-Savart law in vector form

$$\vec{dB} = \frac{\mu_0}{4\pi} I \left(\frac{d\vec{l} \times \vec{r}}{r^3} \right)$$

Magnetic field on the axis of a circular current loop

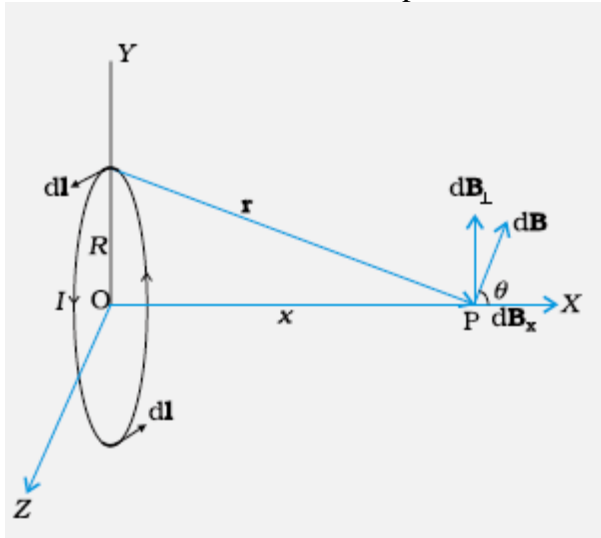

The net magnetic field is along the x-axis only.

Net contribution along X-axis

$$B = \int dB \cos\theta$$

$$\therefore dB = \frac{\mu_0}{4\pi} \frac{I |dl \times r|}{r^3}$$

$$\therefore r^2 = x^2 + R^2$$

$$\therefore dB = \frac{\mu_0}{4\pi} \frac{I dl}{(x^2 + R^2)}$$

$$\therefore B = \int \frac{\mu_0}{4\pi} \frac{I dl}{(x^2 + R^2)} \cdot \cos\theta$$

$$\therefore \cos\theta = \frac{R}{(x^2 + R^2)^{1/2}}$$

$$\therefore B = \int \frac{\mu_0}{4\pi} \frac{R I dl}{(x^2 + R^2)^{3/2}}$$

$$B = \frac{\mu_0}{4\pi} \frac{IR}{(x^2 + R^2)^{3/2}} \int dl$$

$$\therefore \int dl = 2\pi R$$

1

1/2

1/2

1/2

1/2

1/2

	<p>(b) Biot-Savart law can be expressed as Ampere's circuital law by considering the surface to be made up a large number of loops. The sum of the tangential components of the magnetic field multiplied by the length of all such elements, gives the result</p> $\oint \vec{B} \cdot d\vec{l} = \mu_0 I$ <p>Alternatively , Ampere Circuital law and Biot-Savart law , both relate the magnetic field and the current , and both express the same physical consequences of a steady current.</p>	1	5																
t1, Q26 t 2,Q24 t 3,Q25	<table border="1" data-bbox="140 564 1099 665"> <tr> <td>(a) Expression for the Amplitude and the conditions</td> <td>3</td> </tr> <tr> <td>(b) Effect on Interference fringes</td> <td>1 +1</td> </tr> </table> <p>(a) The resultant displacement will be</p> $\vec{y} = \vec{y}_1 + \vec{y}_2$ $= a[\cos \omega t + \cos(\omega t + \phi)]$ $= 2a \cos \frac{\phi}{2} \cos \left(\omega t + \frac{\phi}{2} \right)$ <p>The amplitude of the resultant displacement is $A = 2a \cos \frac{\phi}{2}$</p> <p>$\therefore$ Intensity $A^2 = 4a^2 \cos^2 \frac{\phi}{2}$</p> <p>If $\phi = 0, \pm 2\pi, \pm 4\pi, \dots$ the intensity will be maximum. i.e $\phi = 2n\pi$ $= n\lambda$ where $n = 1, 2, 3 \dots$ Hence interference will be constructive.</p> <p>If $\phi = \pm \pi, \pm 3\pi, \pm 5\pi, \dots$, the intensity will be zero, i.e $\phi = (2n + 1)\pi$ $= (2n + 1) \frac{\lambda}{2}$ where $n=1, 2, 3 \dots$ Hence interference will be destructive.</p> <p>(b)(i) Pattern will become less and less sharp. (ii) At the centre there will be white fringe followed by red colour fringes on either side.</p> <p style="text-align: center;">OR</p> <table border="1" data-bbox="175 1653 1099 1905"> <tr> <td>(a) Diagram</td> <td>1</td> </tr> <tr> <td>Mathematical Proof</td> <td>1 ½</td> </tr> <tr> <td>Graph for δ</td> <td>1</td> </tr> <tr> <td>Conditions</td> <td>½</td> </tr> <tr> <td>(b) Relation to μ</td> <td>½</td> </tr> <tr> <td>Value of μ</td> <td>½</td> </tr> </table>	(a) Expression for the Amplitude and the conditions	3	(b) Effect on Interference fringes	1 +1	(a) Diagram	1	Mathematical Proof	1 ½	Graph for δ	1	Conditions	½	(b) Relation to μ	½	Value of μ	½	½ ½ ½ ½ ½ ½ 1 1	5
(a) Expression for the Amplitude and the conditions	3																		
(b) Effect on Interference fringes	1 +1																		
(a) Diagram	1																		
Mathematical Proof	1 ½																		
Graph for δ	1																		
Conditions	½																		
(b) Relation to μ	½																		
Value of μ	½																		



(a)

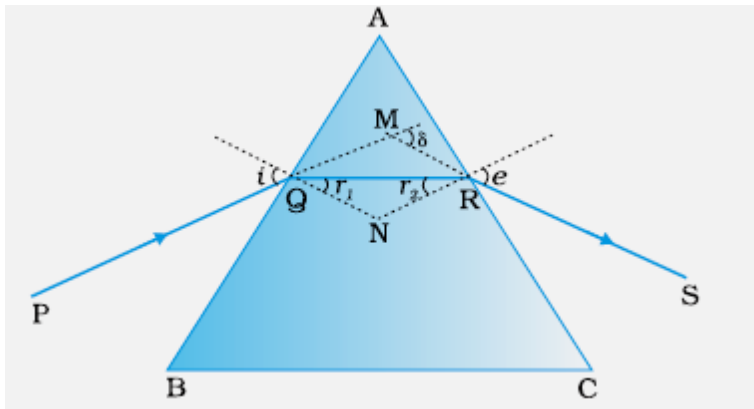

In the quadrilateral AQNR at Q and R, two of the angles are right angles.

Therefore, the sum of the other angles of the quadrilateral is 180°

$$\angle A + \angle QNR = 180^\circ$$

From the triangle QNR,

$$r_1 + r_2 + \angle QNR = 180^\circ$$

Comparing these two equations

$$r_1 + r_2 = A$$

The total deviation δ is the sum of the deviations at the two faces

$$\delta = (i - r_1) + (e - r_2)$$

$$\text{i.e. } \delta = i + e - (r_1 + r_2)$$

$$\delta = i + e - A$$

$$\delta + A = i + e$$

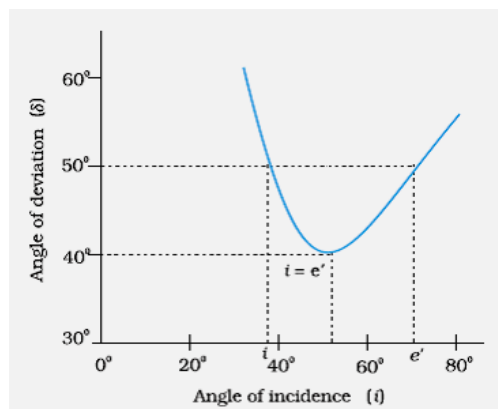

δ will be minimum for $i = e$

(b)

$$\mu = \frac{\sin\left(\frac{A + \delta_m}{2}\right)}{\sin\frac{A}{2}} = \frac{\sin A}{\sin\frac{A}{2}} = 2 \cos\frac{A}{2}$$

If $A = 60^\circ$

1

$\frac{1}{2}$

$\frac{1}{2}$

$\frac{1}{2}$

1

$\frac{1}{2}$

$\frac{1}{2}$

